

Features

- Single-speed whirlpool offers performance and value with 8 fully adjustable jets.
- Hydromassage flow and direction can be controlled at each jet.
- Comfort Depth® design offers a convenient 19" step-over height while retaining the same depth as a standard 21" bath.
- Integral lumbar support.
- Slotted overflow allows for deep soaking.
- Textured bottom surface.
- Coordinates with other products in the Archer collection.

Material

- Acrylic.

Hydrotherapy

- Whirlpool.

Installation

- Reversible drain.
- Drop-in.

Required Products/Accessories

K-7271 Brass Slotted Overflow Bath Drain

or

K-7272 PVC Slotted Overflow Bath Drain

Recommended Products/Accessories

K-24916 Wireless Music Kit

K-23726 Drain treatment

K-23732 Tub & shower cleaner



ADA

Codes/Standards

ASME A112.19.7/CSA B45.10

CSA B45.5/IAPMO Z124

UL 1795

CSA C22.2 No. 218.2

ADA









ICC/ANSI A117.1

KOHLER® Plastic Baths and Receptors Lifetime Limited Warranty
KOHLER® Hydrotherapy Components Five-Year Limited Warranty

See website for detailed warranty information.

Available Colors/Finishes

Color tiles intended for reference only.

Color	Code	Description
	0	White
	96	Biscuit
	NY	Dune
	95	Ice™ Grey
	G9	Sandbar
	33	Mexican Sand™
	K4	Cashmere
	58	Thunder™ Grey
	7	Black Black™

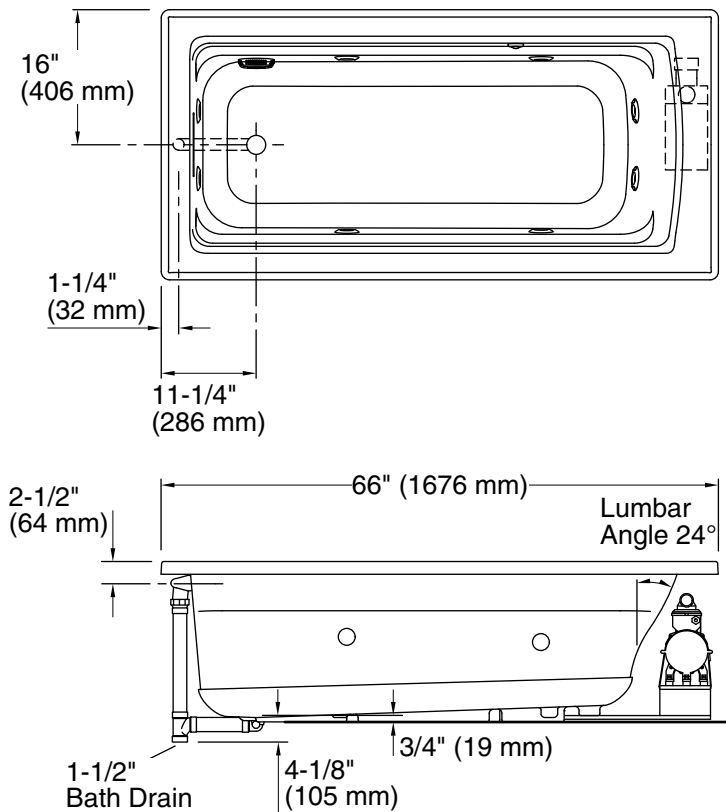

No change in measurements if connected with drain illustrated. (K-7272)

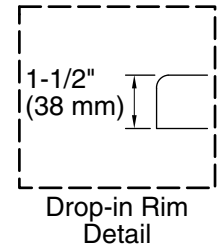

Pump/Control Access
20" (508 mm) W x
15" (381 mm) H

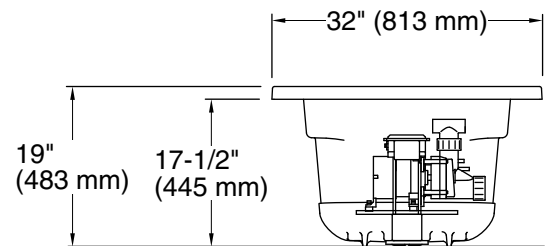

Required Electrical Service

One dedicated circuit required, protected with Class A Ground-Fault Circuit-Interrupter (GFCI). Outside North America, this device may be known as a Residual Current Device (RCD).

Pump: 120 V, 15 A, 60 Hz

Technical Information

All product dimensions are nominal.

Installation: Drop-in

Drain location: End

Basin area, bottom: 50-3/8" x 19-5/8" (1280 mm x 498 mm)

Basin area, top: 57-5/16" x 24-1/16" (1456 mm x 611 mm)

Weight: 106 lbs (48.1 kg)

Minimum floor load: 47 lbs/ft² (229.5 kg/m²)

Water depth: 15-5/16" (389 mm)

Water capacity: 66 gal (249.8 L)

Cutout: Drop-in, 64-1/2" x 30-1/2" (1638 mm x 775 mm)

Electrical component rating: Pump: 120 V, 7 A, 60 Hz

Pump speed: Single

Notes

Measure your actual product for rough-in details.

Install this product according to the installation instructions.

The hot water supply should be 70% of the capacity of the bath or greater. Installations will vary.

This product is designed for drop-in installation only. It is not suited for use in a three-wall alcove with an overhead shower.

ADA compliant when installed to the specific requirements of these regulations.